

Honda / Acura Codes (Can be Stamped or Ink Codes)

Axiom	Ref #:	Codes: (Some codes are found on multiple converters a.k.a. shared)
GM24	BU-38	SE9P, SELP, SF6X, SJ9K
GM85	BU-41	SFL7, SFLT
GM87	BU-41-6	2421-0869 (PWM w/o ECCC / EC ³), 2421-0868, 2421-1228, 2421-1229
GM87CW	BU-41-6CW	2422-0869 (PWM w/ ECCC / EC ³), 2421-3406
HO55	HO-1	4B1, NO, ON, P4
HO56	HO-2HD	A (shared), E (shared), H13, H15, H16, H16C, HAM, HI3, HI6, HK3
HO57	HO-3	13, 15
HO58	HO-4	3, 8 (shared), F
HO59	HO-5	7 (shared), 59, B (shared), R (shared)
HO60	HO-6	2N, E (shared)
HO61	HO-7	4F, 8 (shared), 45, 45H, 61, B (shared), C (shared), F4, FM4, J, M (shared), PH45
HO62	HO-8	5 (shared), 27, 27M, 27N, L5, N, PL5, PXL5
HO63	HO-9	25, 25AR, K
HO64	HO-10	A (shared), A8, AB (shared), AL, B (shared), C8, J (shared), L4, L15, L-15, L16, L-16, P1, S15, S-15, S16, S-16
HO65	HO-11	3K, ☐ (square), K1, K2, K3, K4, M (shared), P, Y8
HO66	HO-12	4 (shared), 4B0, 4B6, 4B-6, 4BC, 4M (shared), 7 (shared), GO4, J (shared), M (shared), MPXA, M4, PX4B, P5N, S4XA
HO67	HO-13	C (shared), R18
HO68	HO-14	68, =, R (shared), Y4
HO69	HO-16	215, 216, A (shared), AB (shared), A24A, A5 P72, B (shared), B4RA, b6, B7MA, B7MAJB4, ba (shared) BB, BJE, BMXA, JB4, M24A, M4RA, M4TA, MDLA, MDMA, MP7A, P5, P56, P72, SDMA, SP7A
HO71	HO-15	5 (shared), MPWA, M1WA, PWA, PW7, Y
HO72	HO-17	6, 6AA, AAO, AOYA, AYA, b (shared), B (shared), b-AYA, B3X06A3, B4H23A2, B5B, EH23A, FBAA, I, q (shared), RA
HO74	n/a	L, PR
HO75	n/a	PL1, PW4, Y (shared)
HO76	HO-18	5 (shared), B5, B7XA, J (shared), LJ, MPZA, PAA, PO, POG
HO77	HO-27	4 (shared), 4M (shared), 5M, 8b, BAXA (shared), BCA, EA, GA, HX15BA, M (shared), MAXA, P5M, YCA
HO78	HO-25	8B, 8b, BA, b (shared), B (shared), BAXA (shared), B6K29A7, CA, C8C121A4, PAA, PCA, PEA, q (shared)
HO79	HO-26	4 (shared), 5 (shared), 8c, 8C, B05, B7XA, BAXA (shared), C7X, E7E, J (shared), M7ZA, P8A, P8C, U
HO80	HO-80	4A3, 8F, 602019 E2-P8F, B7TA, B7VA, B7WA, B7YA, BYBA, C2X17B17, M7WA, OX17C6, P8F, PG
HO81	HO-81	NA, PN, PN276580

Honda / Acura Codes (Can be Stamped or Ink Codes)

Codes:	Axiom	Ref #:
3	HO58	HO-4
6	HO72	HO-17
13	HO57	HO-3
15	HO57	HO-3
25	HO63	HO-9
27	HO62	HO-8
45	HO61	HO-7
59	HO59	HO-5
61	HO61	HO-7
68	HO68	HO-14
215	HO69	HO-16
216	HO69	HO-16
=	HO68	HO-14
⊠ (square)	HO65	HO-11
2421 0868	GM87	BU-41-6
2421 0869 (PWM w/o ECCC/EC ³)	GM87	BU-41-6
2421 1228	GM87	BU-41-6
2421 1229	GM87	BU-41-6
2421 3406	GM87CW	BU-41-6CW
2422 0869 (PWM w/ ECCC/EC ³)	GM87CW	BU-41-6CW
25AR	HO63	HO-9
27M	HO62	HO-8
27N	HO62	HO-8
2N	HO60	HO-6
3K	HO65	HO-11
4 (114 T RG, Beveled Pilot)	HO66	HO-12
4 (114 T RG, Rounded Pilot)	HO77	HO-27
4 (121 T Ring Gear)	HO79	HO-26
45H	HO61	HO-7
4A3	HO80	HO-80
4B0	HO66	HO-12
4B1	HO55	HO-1
4B6	HO66	HO-12
4B-6	HO66	HO-12
4BC	HO66	HO-12
4F	HO61	HO-7
4M (114 T RG, Beveled Pilot)	HO66	HO-12
4M (114 T RG, Rounded Pilot)	HO77	HO-27
5 (114 T Ring Gear)	HO62	HO-8
5 (121 T RG, 0 Dowel Pins)	HO79	HO-26
5 (121 T Ring Gr, 2 Dowel Pins)	HO76	HO-18
5 (No Ring Gear)	HO71	HO-15
5M	HO77	HO-27
602019 E2-P8F	HO80	HO-80
6AA	HO72	HO-17
7 (103 T Ring Gear)	HO59	HO-5
7 (114 T Ring Gear)	HO66	HO-12
8 (36 T Hub)	HO58	HO-4
8 (38 T Hub)	HO61	HO-7
8B	HO78	HO-25
8b (See photo page 89)	HO78	HO-25
8b (See photo page 89)	HO77	HO-27
8c	HO79	HO-26
8C	HO79	HO-26
8F	HO80	HO-80

Codes:	Axiom	Ref #:
A (103 T Ring Gear)	HO56	HO-2HD
A (107 T Ring Gear)	HO64	HO-10
A (109 T Ring Gear)	HO69	HO-16
A24A	HO69	HO-16
A5 P72	HO69	HO-16
A8	HO64	HO-10
AAO	HO72	HO-17
AB (107 T Ring Gear)	HO64	HO-10
AB (109 T Ring Gear)	HO69	HO-16
AL	HO64	HO-10
AOYA	HO72	HO-17
AYA	HO72	HO-17
b (114 T RG, Rounded Pilot)	HO78	HO-25
b (114 T, .355" Thick Ring Gear)	HO72	HO-17
B (103 T RG, 36 T Hub)	HO59	HO-5
B (103 T RG, 38 T Hub)	HO61	HO-7
B (107 T Ring Gear)	HO64	HO-10
B (109 T Ring Gear)	HO69	HO-16
B (114 T, .275" Thick Ring Gear)	HO78	HO-25
B (114 T, .355" Thick Ring Gear)	HO72	HO-17
b AYA	HO72	HO-17
B05	HO79	HO-26
B3X06A3	HO72	HO-17
B4H23A2	HO72	HO-17
B4RA	HO69	HO-16
B5	HO76	HO-18
B5B	HO72	HO-17
b6	HO69	HO-16
B6K29A7	HO78	HO-25
B7MA	HO69	HO-16
B7MAJB4	HO69	HO-16
B7TA	HO80	HO-80
B7VA	HO80	HO-80
B7WA	HO80	HO-80
B7XA (121 T Ring Gr, 0 Dowel Pins)	HO79	HO-26
B7XA (121 T Ring Gr, 2 Dowel Pins)	HO76	HO-18
B7YA	HO80	HO-80
BA (114 T Ring Gear)	HO78	HO-25
BA (109 T Ring Gear)	HO69	HO-16
BAXA (114 T RG)(See photo page 93)	HO78	HO-25
BAXA (114 T RG)(See photo page 93)	HO77	HO-27
BAXA (121 T RG)	HO79	HO-26
BB	HO69	HO-16
BCA	HO77	HO-27
BJE	HO69	HO-16
BMXA	HO69	HO-16
BYBA	HO80	HO-80
C (103 T Ring Gear)	HO61	HO-7
C (114 T Ring Gear)	HO67	HO-13
C2X17B17	HO80	HO-80
C7X	HO79	HO-26
C8	HO64	HO-10
C8C121A4	HO78	HO-25
CA	HO78	HO-25
E (36 T Hub)	HO56	HO-2HD
E (38 T Hub)	HO60	HO-6

Honda / Acura Codes (Can be Stamped or Ink Codes)

Codes:	Axiom	Ref #:	Codes:	Axiom	Ref #:
E7E	HO79	HO-26	N	HO62	HO-8
EA	HO77	HO-27	NA	HO81	HO-81
EH23A	HO72	HO-17	NO	HO55	HO-1
F	HO58	HO-4	ON	HO55	HO-1
F4	HO61	HO-7	OX17C6	HO80	HO-80
FBAA	HO72	HO-17	P	HO65	HO-11
FM4	HO61	HO-7	P1	HO64	HO-10
GA	HO77	HO-27	P4	HO55	HO-1
GO4	HO66	HO-12	P5	HO69	HO-16
H13	HO56	HO-2HD	P56	HO69	HO-16
H15	HO56	HO-2HD	P5M	HO77	HO-27
H16	HO56	HO-2HD	P5N	HO66	HO-12
H16C	HO56	HO-2HD	P72	HO69	HO-16
HAM	HO56	HO-2HD	P8A	HO79	HO-26
HI3	HO56	HO-2HD	P8C	HO79	HO-26
HI6	HO56	HO-2HD	PAA	HO76	HO-18
HK3	HO56	HO-2HD	PAA	HO78	HO-25
HX15BA	HO77	HO-27	PCA	HO78	HO-25
I	HO72	HO-17	PEA	HO78	HO-25
J (103 T Ring Gear)	HO61	HO-7	PEF	HO80	HO-80
J (107 T Ring Gear)	HO64	HO-10	PG	HO80	HO-80
J (114 T Ring Gear)	HO66	HO-12	PH45	HO61	HO-7
J (121 T Ring Gr, 0 Dowel Pins)	HO79	HO-26	PL1	HO75	n/a
J (121 T Ring Gr, 2 Dowel Pins)	HO76	HO-18	PL5	HO62	HO-8
JB4	HO69	HO-16	PN	HO81	HO-81
K	HO63	HO-9	PN276580	HO81	HO-81
K1	HO65	HO-11	PO	HO76	HO-18
K2	HO65	HO-11	POG	HO76	HO-18
K3	HO65	HO-11	PR	HO74	n/a
K4	HO65	HO-11	PW4	HO75	n/a
L	HO74	n/a	PW7	HO71	HO-15
L15	HO64	HO-10	PWA	HO71	HO-15
L-15	HO64	HO-10	PX4B	HO66	HO-12
L16	HO64	HO-10	PXL5	HO62	HO-8
L-16	HO64	HO-10	q (114 T, .275" Thick Ring Gear)	HO78	HO-25
L4	HO64	HO-10	q (114 T, .355" Thick Ring Gear)	HO72	HO-17
L5	HO62	HO-8	R (103 T Ring Gear)	HO59	HO-5
LJ	HO76	HO-18	R (No Ring Gear)	HO68	HO-14
M (103 T Ring Gear)	HO61	HO-7	R18	HO67	HO-13
M (107 T Ring Gear)	HO65	HO-11	RA	HO72	HO-17
M (114 T RG, Beveled Pilot)	HO66	HO-12	S15, S-15	HO64	HO-10
M (114 T RG, Rounded Pilot)	HO77	HO-27	S16, S-16	HO64	HO-10
M1WA	HO71	HO-15	S4XA	HO66	HO-12
M24A	HO69	HO-16	SDMA	HO69	HO-16
M4	HO66	HO-12	SE9P	GM24	BU-38
M4RA	HO69	HO-16	SELP	GM24	BU-38
M4TA	HO69	HO-16	SF6X	GM24	BU-38
M7WA	HO80	HO-80	SFL7	GM85	BU-41
M7ZA	HO79	HO-26	SFLT	GM85	BU-41
MAXA	HO77	HO-27	SJ9K	GM24	BU-38
MDLA	HO69	HO-16	SP7A	HO69	HO-16
MDMA	HO69	HO-16	U	HO79	HO-26
MP7A	HO69	HO-16	Y (1" Tall Pilot)	HO71	HO-15
MPWA	HO71	HO-15	Y (1.5" Tall Pilot)	HO75	n/a
MPXA	HO66	HO-12	Y4	HO68	HO-14
MPZA	HO76	HO-18	Y8	HO65	HO-11
			YCA	HO77	HO-27

Honda (No Ring Gear) (Honda Transmissions)

Ref: HO-14	6 Pads, No Mounting Ring			
HO68	1991-95 Acura Legend MPYA			
	Codes: 68, =, Y4			
	Shared Codes: R			
	Type: Lock Up	Hub: 39 T (1.55"OD)		
Outer Dia: 11.125"	Input Splines: 23	* O-ring Not Included		
Bolt Circle: 9.875"	No Coast Relief Valve			
Overall Height: 5.85"	Pilot Dia: .945"			

Ref: N/A	8 Mounting Holes, 0 Dowel Pins			
HO75	Codes: PL1, PW4			
	Shared Codes: Y			
	Type: Lock Up	Hub: 38 T (1.52"OD)		
	Mtg Ring Outer: 9.925"	Input Splines: 19		
	Bolt Circle: 9.325"	No Coast Relief Valve		
Mtg Ring Inner: 8.815"	Overall Height: 4.975"	* O-ring Not Included		
8 Tapped Holes	Pilot Dia: .945"			

Ref: HO-15	8 Mounting Holes, 0 Dowel Pins			
HO71	1992-94 Acura Vigor MPWA			
	Codes: 5 (shared), PW7, Y			
	Type: Lock Up	Hub: 38 T (1.52"OD)		
	Mtg Ring Outer: 9.965"	Input Splines: 19		
	Bolt Circle: 9.379"	No Coast Relief Valve		
Mtg Ring Inner: 8.865"	Overall Height: 5.225"	* O-ring Not Included		
8 Tapped Holes	Pilot Dia: .945"			

Honda (103 Tooth Ring Gear)

Ref: HO-1	19 Splines, 36 T Hub, 2 Dowel Pins			
HO55	1984-86 Accord 1.8L			
	Codes: 4B1, NO, ON, P4			
	Type: Lock Up	Hub: 36 T (1.43" OD)		
	Mtg Ring Outer: 10.475"	Input Splines: 19		
	Bolt Circle: 9.875"	Coast Relief Valve		
Mtg Ring Inner: 9.545"	Overall Height: 4.525"	* O-ring Not Included		
8 Tapped Holes	Pilot Dia: .945"			

Ref: HO-2HD	19 Splines, 36 T Hub, 2 Dowel Pins			
HO56	1986-87 Integra, Civic, Prelude, CRX			
	Codes: H13, H15, H16, H16C, HAM, HK2			
	Shared Codes: A, E			
	Type: Lock Up	Hub: 36 T (1.43" OD)		
	Mtg Ring Outer: 10.475"	Input Splines: 19		
Bolt Circle: 9.875"	No Coast Relief Valve	* O-ring Not Included		
Mtg Ring Inner: 9.545"	Overall Height: 4.525"			
8 Tapped Holes	Pilot Dia: .945"			

Honda (103 Tooth Ring Gear) (cont.)

Ref: HO-5	19 Splines, 36 T Hub, 2 Dowel Pins		
HO59	1983-85 Prelude Codes: 59 Shared Codes: 7, B, R		
	Type: Non Lock Up Hub: 36 T (1.43" OD)		
	Mtg Ring Outer: 10.475" Input Splines: 19		
	Bolt Circle: 9.875" No Coast Relief Valve		
	Mtg Ring Inner: 9.545" Overall Height: 4.525"		
	8 Tapped Holes Pilot Dia: .945"		
		* O-ring Not Included	
HO57	1981-85 Civic, CRX 3 Speed Codes: 13, 15		
	Type: Lock Up Hub: 36 T (1.43" OD)		
	Mtg Ring Outer: 10.475" Input Splines: 19		
	Bolt Circle: 9.875" Coast Relief Valve		
	Mtg Ring Inner: 9.545" Overall Height: 4.975"		
	8 Tapped Holes Pilot Dia: .945"		
		* O-ring Not Included	
HO58	1986-87 Civic, CRX 4 Speed Codes: 3, F Shared Codes: 8		
	Type: Lock Up Hub: 36 T (1.43" OD)		
	Mtg Ring Outer: 10.475" Input Splines: 19		
	Bolt Circle: 9.875" No Coast Relief Valve		
	Mtg Ring Inner: 9.545" Overall Height: 4.975"		
	8 Tapped Holes Pilot Dia: .945"		
		* O-ring Not Included	
HO60	1985-86 Accord, Prelude w/ F.I. Codes: 2N Shared Codes: E		
	Type: Lock Up Hub: 38 T (1.52" OD)		
	Mtg Ring Outer: 10.475" Input Splines: 22		
	Bolt Circle: 9.875" Coast Relief Valve		
	Mtg Ring Inner: 9.545" Overall Height: 4.525"		
	8 Tapped Holes Pilot Dia: .945"		
		* O-ring Not Included	
HO61	1986-89 Accord, 1986 Prelude F4 Codes: 4F, 45, 45H, 61, F4, FM4, PH45 Shared Codes: 8, B, C, J, M		
	Type: Lock Up Hub: 38 T (1.52" OD)		
	Mtg Ring Outer: 10.475" Input Splines: 22		
	Bolt Circle: 9.875" No Coast Relief Valve		
	Mtg Ring Inner: 9.545" Overall Height: 4.525"		
	8 Tapped Holes Pilot Dia: .945"		
		* O-ring Not Included	

Honda 103 T Ring Gear

Honda (107 Tooth Ring Gear)

Ref: HO-10	19 Splines, 2 Dowels Pins		
HO64	87-89 Integra, 87-91 Civic 1.5L, 88 Prelude Codes: A8, AL, L15, L16, S15, S16 Shared Codes: A, AB, B, J		
	Type: Lock Up Hub: 38 T (1.52" OD)		
	Mtg Ring Outer: 10.475" Input Splines: 19		
	Bolt Circle: 9.875" No Coast Relief Valve		
	Mtg Ring Inner: 9.545" Overall Height: 4.525"		
8 Tapped Holes Pilot Dia: .945"	* O-ring Not Included		

Ref: HO-11	22 Splines, 2 Dowel Pins		
HO65	1988-91 Prelude 2.0L K4, PY8A Codes: 3K, K1, K2, K3, K4, P, Y8 Shared Codes: M		
	Type: Lock Up Hub: 38 T (1.52" OD)		
	Mtg Ring Outer: 10.85" Input Splines: 22		
	Bolt Circle: 10.25" Coast Relief Valve		
	Mtg Ring Inner: 9.95" Overall Height: 4.680"		
8 Tapped Holes Pilot Dia: .945"	* O-ring Not Included		

Honda (109 Tooth Ring Gear)

Ref: HO-16	22 Splines, 2 Dowel Pins		
HO69	M24A, A24A, SP7A, MP7A, MDLA, SDMA Codes: 215, 216, P56, P72 Shared Codes: A, AB, B		
	Type: Lock Up Hub: 38 T (1.52" OD)		
	Mtg Ring Outer: 10.475" Input Splines: 22		
	Bolt Circle: 9.875" No Coast Relief Valve		
	Mtg Ring Inner: 9.545" Overall Height: 4.562"		
8 Tapped Holes Pilot Dia: .945"	* O-ring Not Included		

Honda (114 Tooth Ring Gear) (0 Dowel Pins)

Ref: HO-17	22 Splines, 0 Dowel Pins			
HO72	1994-97 Accord 2.2L AOYA Codes: 6, 6AA, AAO, AYA, B3X06A3, B4H23A2, B5B, EH23A, FBAA, I, RA Shared Codes: b, B, q			
	Type: Lock Up	Hub: 38 T (1.52" OD)		
	Mtg Ring Outer: 10.345"	Input Splines: 22		
	Bolt Circle: 9.865"	No Coast Relief Valve		
	Mtg Ring Inner: 9.539"	Overall Height: 4.665"		
8 Tapped Holes	Pilot Dia: .945"	* O-ring Not Included		

Ref: HO-12	22 Splines, 0 Dowel Pins			
HO66	89-93 Accord LX 2.2L, 92 Prelude (PX4B, MPXA, S4XA, APX4, MYBA) Codes: 4B0, 4B6, 4BC, GO4 Shared Codes: 4, 4M, 7, J, M			
	Type: Lock Up	Hub: 38 T (1.52" OD)		
	Mtg Ring Outer: 10.865"	Input Splines: 22		
	Bolt Circle: 10.25"	No Coast Relief Valve		
	Mtg Ring Inner: 9.945"	Overall Height: 4.680"		
8 Tapped Holes	Pilot Dia: .945"	* O-ring Not Included		

Ref: HO-25	22 Splines, 0 Dowel Pins (.275" Thick Gear)			
HO78	97-Up Honda, Acura 4 Cyl Codes: 8b, 8B, B6K29A7, C8C12144, PAA, PCA, PEA Shared Codes: b, B, q			
	Type: Lock Up	Hub: 38 T (1.52" OD)		
	Mtg Ring Outer: 10.865"	Input Splines: 22		
	Bolt Circle: 10.25"	No Coast Relief Valve		
	Mtg Ring Inner: 9.945"	Overall Height: 4.670"		
8 Tapped Holes	Pilot Dia: .945"	* O-ring Not Included		

Ref: HO-27	22 Splines, 0 Dowel Pins (.355" Thick Gear)			
HO77	97-Up Prelude, Acura, CL 4 Cyl Codes: 5M, EA, GA, HX15BA, P5M Shared Codes: 4, 4M, M			
	Type: Lock Up	Hub: 38 T (1.52" OD)		
	Mtg Ring Outer: 10.865"	Input Splines: 22		
	Bolt Circle: 10.25"	No Coast Relief Valve		
	Mtg Ring Inner: 9.945"	Overall Height: 4.680"		
8 Tapped Holes	Pilot Dia: .945"	* O-ring Not Included		

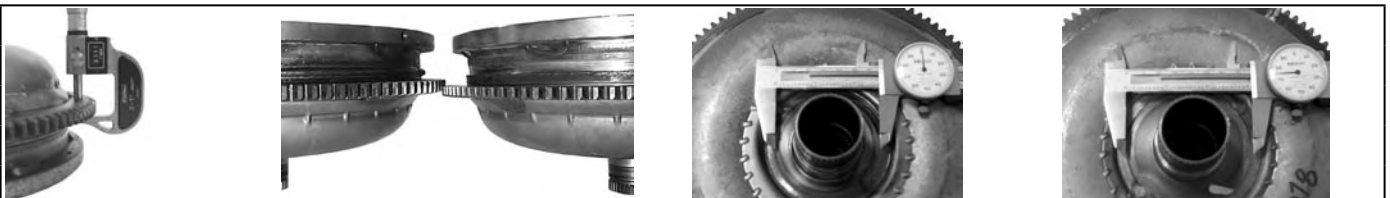

HO77 - .355" Thick Ring Gear HO78 - .275" Thick Ring Gear HO77 - 2.600" Flanged Impeller Hub HO78 - 3.075" Flanged Impeller Hub

Honda (114 Tooth Ring Gear) (2 Dowel Pins)

Ref: HO-13	22 Splines, 2 Dowel Pins			
HO67	1990-Up Acura Integra			
	Codes: R18			
	Shared Codes: C			
	Type: Lock Up			Hub: 38 T (1.52" OD)
	Mtg Ring Outer: 10.475"			Input Splines: 22
Bolt Circle: 9.875"	No Coast Relief Valve			
Mtg Ring Inner: 9.545"	Overall Height: 4.580"			
8 Tapped Holes	Pilot Dia: .945"	* O-Ring Not Included		

Ref: HO-9	22 Splines, 2 Dowel Pins			
HO63	1986-87 Legend 2.5L G4			
	Codes: 25, 25AR, K			
	Type: Lock Up			Hub: 38 T (1.52" OD)
	Mtg Ring Outer: 11.415"			Input Splines: 22
	Bolt Circle: 10.875"			No Coast Relief Valve
Mtg Ring Inner: 10.375"	Overall Height: 4.640"			
8 Tapped Holes	Pilot Dia: .945"	* O-Ring Not Included		

Ref: HO-8	22 Splines, 2 Dowel Pins			
HO62	1987-91 Acura, Legend, Sterling L5 & PL5X			
	Codes: 27, 27M, 27N, N			
	Shared Codes: 5			
	Type: Lock Up			Hub: 38 T (1.52" OD)
	Mtg Ring Outer: 11.415"			Input Splines: 22
Bolt Circle: 10.875"	No Coast Relief Valve			
Mtg Ring Inner: 10.375"	Overall Height: 4.780"			
8 Tapped Holes	Pilot Dia: .945"	* O-Ring Not Included		

Honda (118 Tooth Ring Gear)

Ref: N/A	23 Splines, 0 Dowel Pins			
HO74	1991-93 NSX, Codes: L, PR			
	Type: Lock Up			Hub: 39 T (1.55" OD)
	Mtg Ring Outer: 11.75"			Input Splines: 23
	Bolt Circle: 11.275"			No Coast Relief Valve
	Mtg Ring Inner: 10.765"			Overall Height: 4.975"
8 Tapped Holes	Pilot Dia: .945"	* O-Ring Not Included		

Honda (119 Tooth Ring Gear)

Ref: HO-81	22 Splines, 0 Dowel Pins			
HO81	02-04 Acura RSX (MRMA)			
	Codes: NA, PN, PN276581			
	Type: Lock Up			Hub: 38 T (1.575" OD)
	Ring Gear Outer: 12"			Input Splines: 22
	Bolt Circle: 10.8"			No Coast Relief Valve
Ring Gear Inner: 10"	Overall Height: 3.995"			
8 Tapped Holes	Pilot Dia: .945"	* O-Ring Not Included		

Honda (121 Tooth Ring Gear)

Ref: HO-26	22 Splines		
HO79	95-Up Accord V6 B7XA, MPZA, M6HA Codes: 8c, B05, E7E, LJ, P8A, P8C, PO, POG, U Shared Codes: 4, 5, J		
	Type: Lock Up	Hub: 38 T (1.52" OD)	
	Mtg Ring Outer: 11.415"	Input Splines: 22	
	Bolt Circle: 10.875"	No Coast Relief Valve	
	Mtg Ring Inner: 10.375"	Overall Height: 4.842"	
	8 Tapped Holes	Pilot Dia: .945"	
		* O-ring Not Included	
Ref: HO-80	22 Splines		
HO80	99-Up Odyssey 3.5, Acura 3.2 B7TA, B7VA, B7YA Codes: 8F, 602019, E2-P8F, C2X17B17, OX17C6		
	Type: Lock Up	Hub: 38 T (1.52" OD)	
	Mtg Ring Outer: 11.815"	Input Splines: 22	
	Bolt Circle: 11.215"	No Coast Relief Valve	
	Mtg Ring Inner: 10.775"	Overall Height: 4.758"	
	8 Tapped Holes	Pilot Dia: .945"	
		* O-ring Not Included	